

CUSTOMER:	
JOB:	MOLD: 18"X30"CC-4
BAY#: 156-A	STONE COLOR:
DATE:	SCALE: 1"=12" NEED:

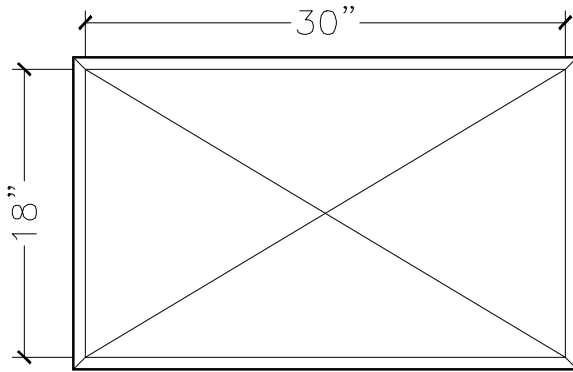

TOP VIEW

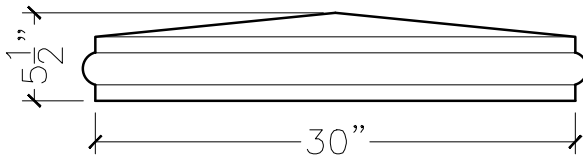

FRONT VIEW

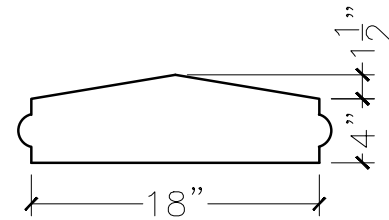

SECTION VIEW