

CUSTOMER:	
JOB:	MOLD: BB-53
BAY# 86	STONE COLOR:
DATE:	SCALE: 1 $\frac{1}{2}$ "=12" NEED:

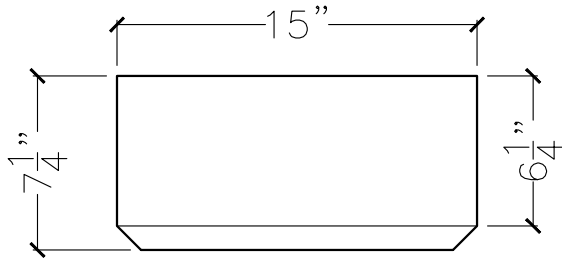

TOP VIEW

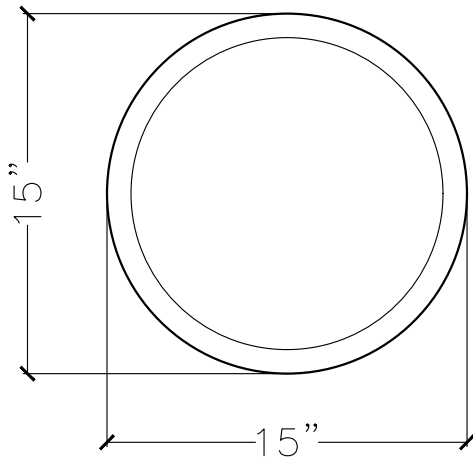

FRONT VIEW

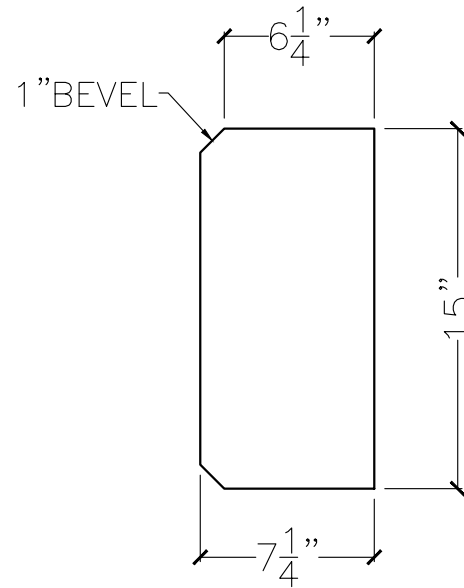

SECTION VIEW