

CUSTOMER:		
JOB:	MOLD: BB-59	
BAY#: 86	STONE COLOR:	
DATE:	SCALE: 1"=12"	NEED:

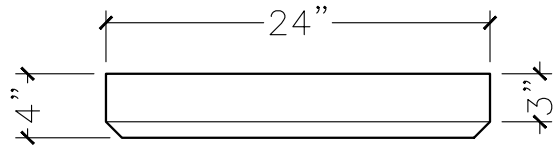

TOP VIEW

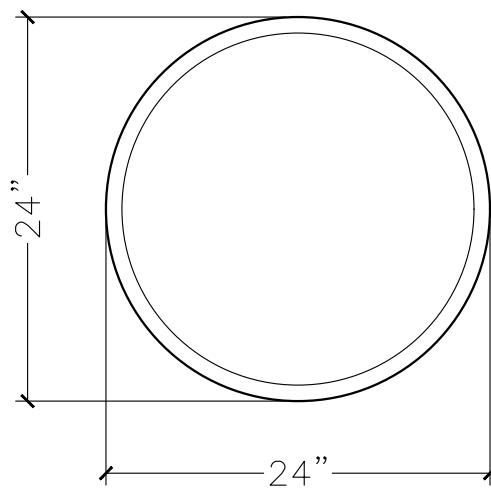

FRONT VIEW

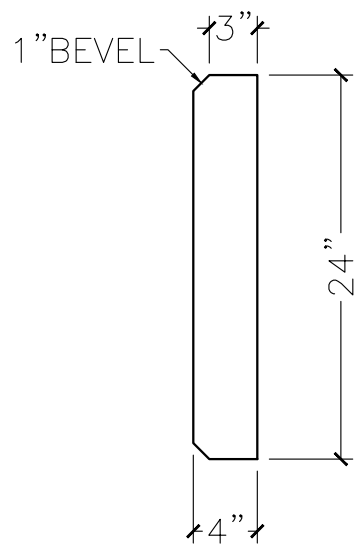

SECTION VIEW