

CUSTOMER:		
JOB:	MOLD: CC-236	
BAY#: 159-B	STONE COLOR:	
DATE:	SCALE: 1"=12"	NEED:

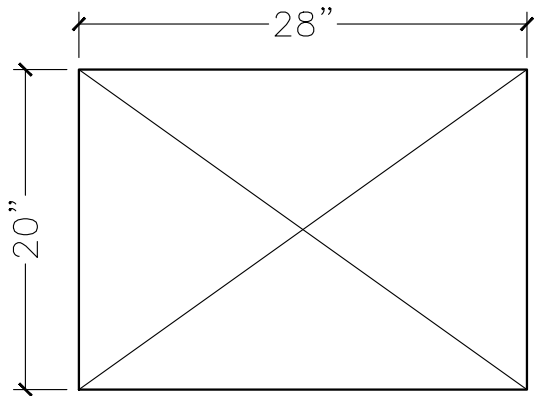

TOP VIEW

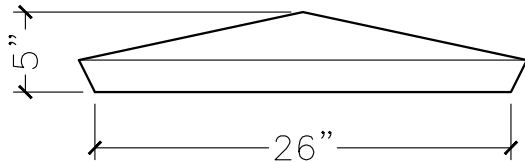

FRONT VIEW

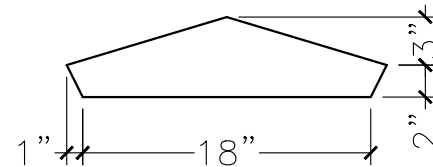

SECTION VIEW