

| | | |
|-------------|---------------|-------|
| CUSTOMER: | | |
| JOB: | MOLD: CC-383 | |
| BAY#: 336-A | STONE COLOR: | |
| DATE: | SCALE: 1"=12" | NEED: |

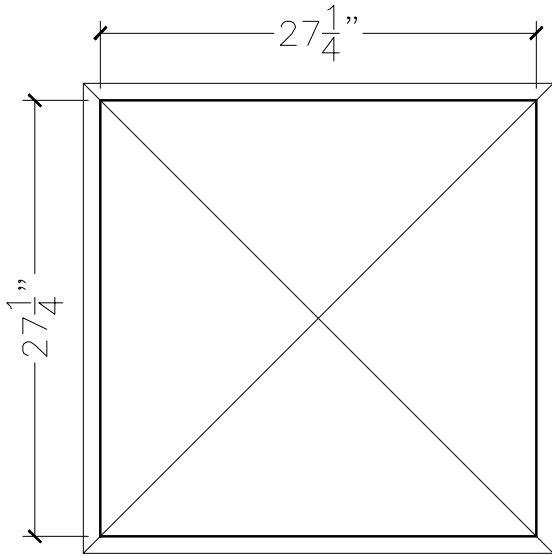

TOP VIEW

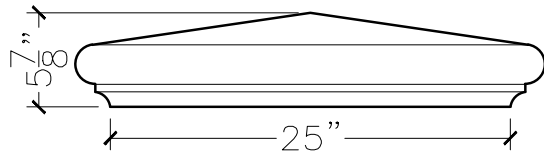

FRONT VIEW

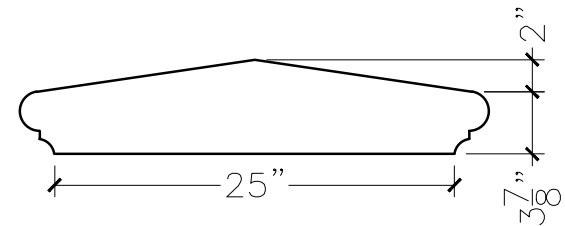

SECTION VIEW