

CUSTOMER:	
JOB:	MOLD: CC-397
BAY#: 160-A	STONE COLOR:
DATE:	SCALE: 1"=12"      NEED:

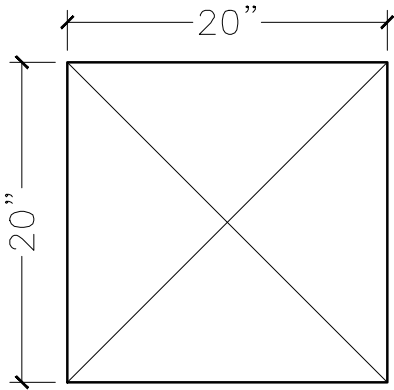

TOP VIEW

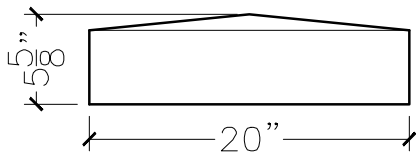

FRONT VIEW

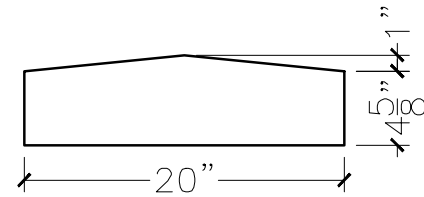

SECTION VIEW