

CUSTOMER:	
JOB:	MOLD: CC-469
BAY#: 256-B	STONE COLOR:
DATE:	SCALE: 1"=12" NEED:

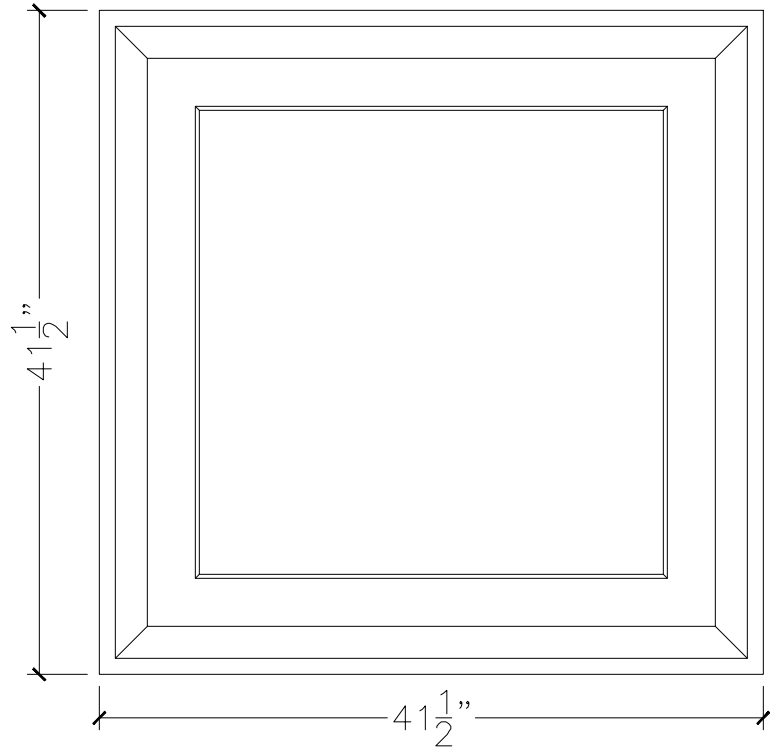

TOP VIEW

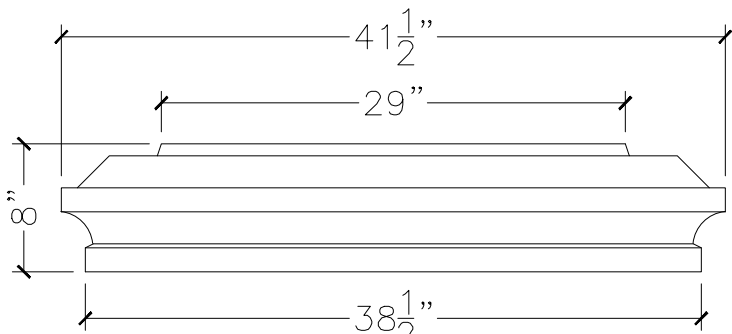

FRONT VIEW

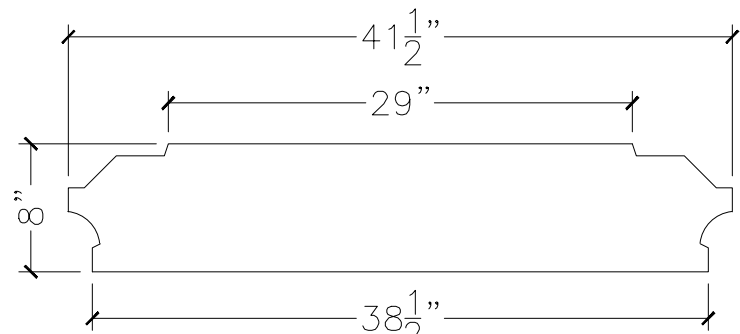

SECTION VIEW