

CUSTOMER:	
JOB:	MOLD: CC-487
BAY#: 320-B	STONE COLOR:
DATE:	SCALE: 1"=12" NEED:

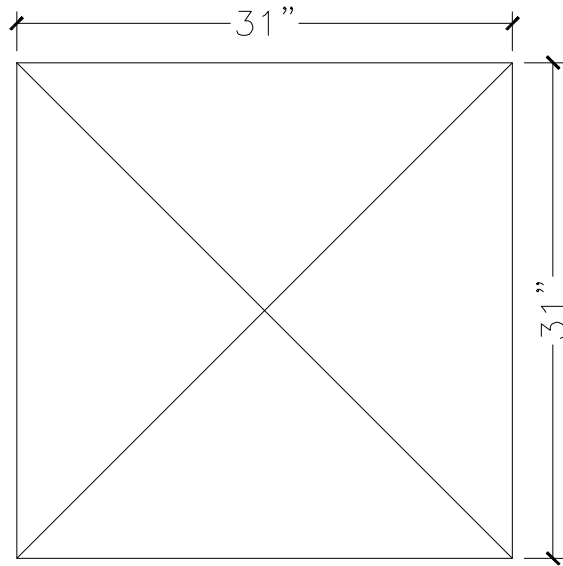

TOP VIEW

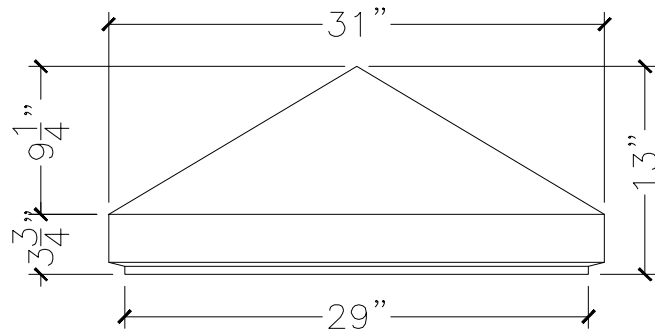

FRONT VIEW

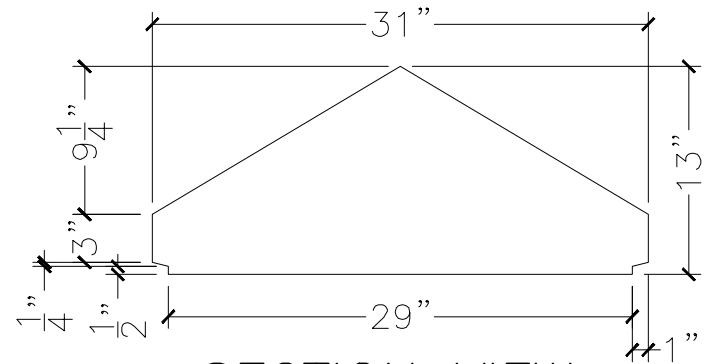

SECTION VIEW