

CUSTOMER:	
JOB:	MOLD: CC-165
BAY#: 340	STONE COLOR:
DATE:	SCALE: $\frac{1}{2}''=12''$ NEED:

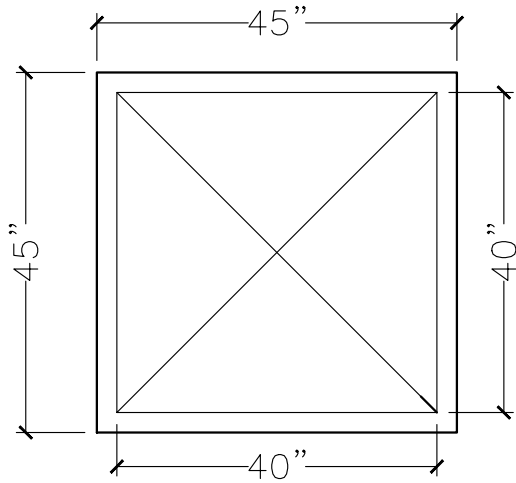

TOP VIEW

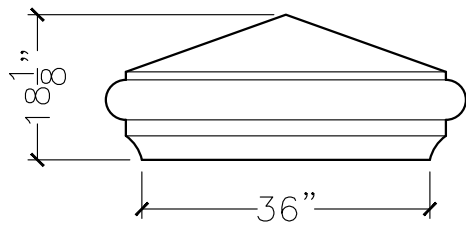

FRONT VIEW

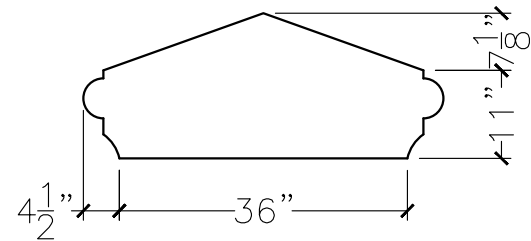

SECTION VIEW