

CUSTOMER:	
JOB:	MOLD: CC-25
BAY#: 94-A	STONE COLOR:
DATE:	SCALE: 1"=12"      NEED:

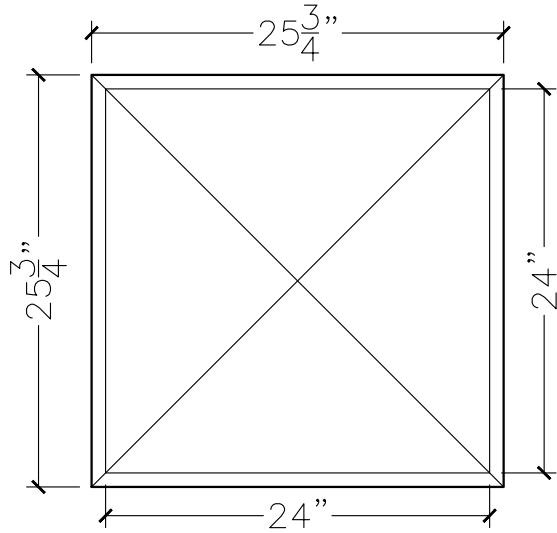

TOP VIEW

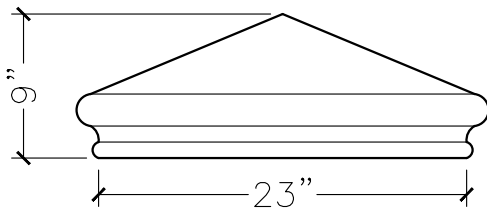

FRONT VIEW

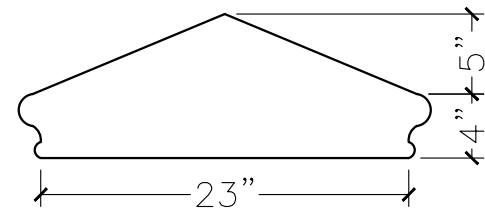

SECTION VIEW