

CUSTOMER:	
JOB:	MOLD: CC-33
BAY#: 94-B	STONE COLOR:
DATE:	SCALE: 1"=12" NEED:

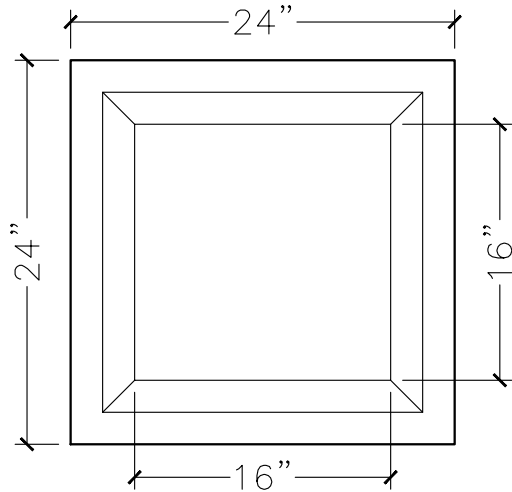

TOP VIEW

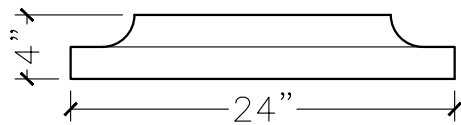

FRONT VIEW

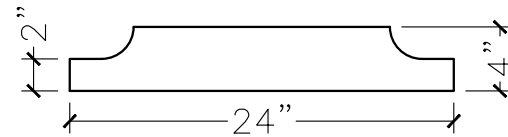

SECTION VIEW