

JOB:	MOLD: CC-56	
BAY# 113-A	STONE COLOR:	
DATE:	SCALE: $\frac{3}{4}'' = 12''$	NEED:

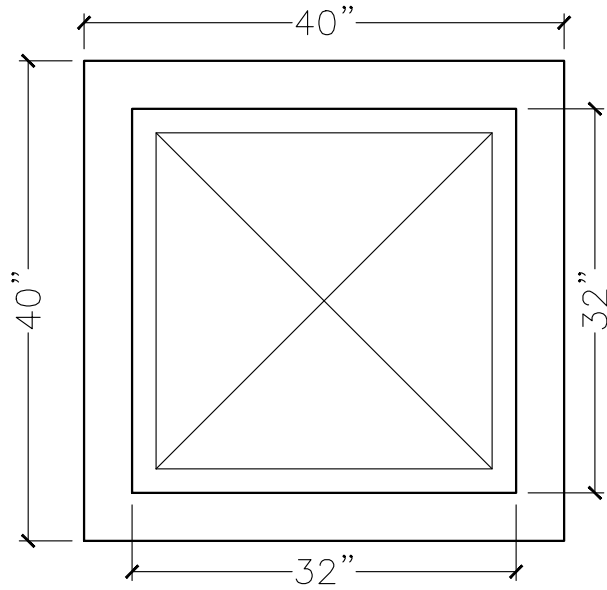

TOP VIEW

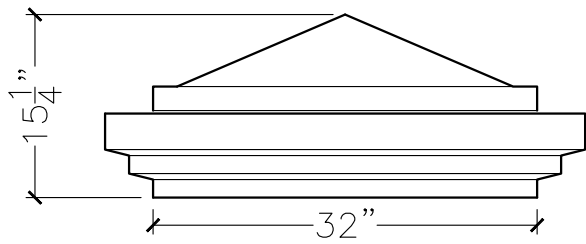

FRONT VIEW

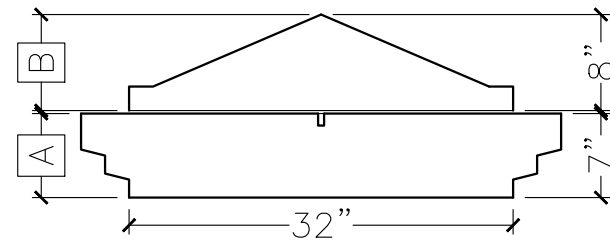

SECTION VIEW