

CUSTOMER:	
JOB:	MOLD: DB-8
BAY#: 92	STONE COLOR:
DATE:	SCALE: 3"=12" NEED:

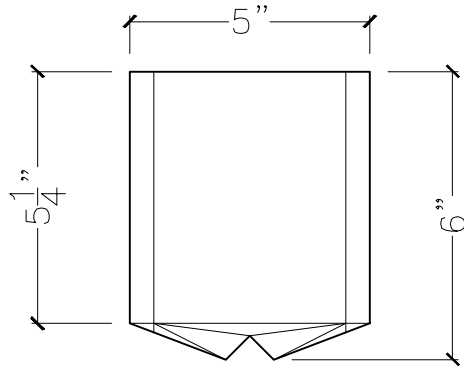

TOP VIEW

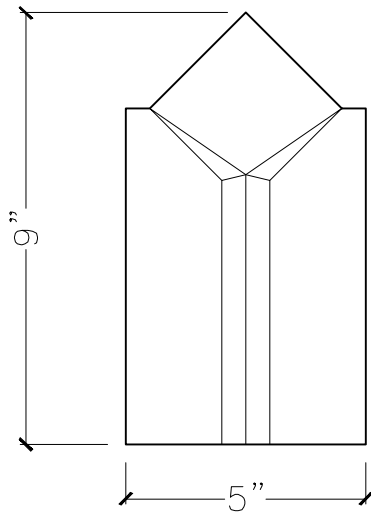

FRONT VIEW

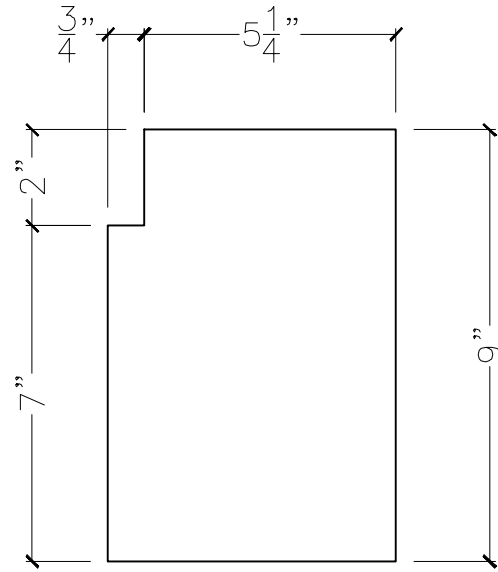

SECTION VIEW