

JOB:	MOLD: WL-8 29 $\frac{1}{4}$ "RADIUS
BAY#: 16-A	STONE COLOR:
DATE:	SCALE: 1"=12" NEED:

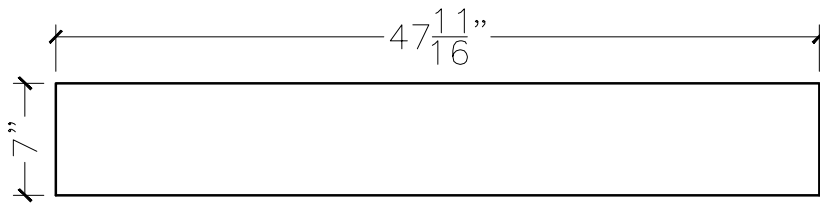

TOP VIEW

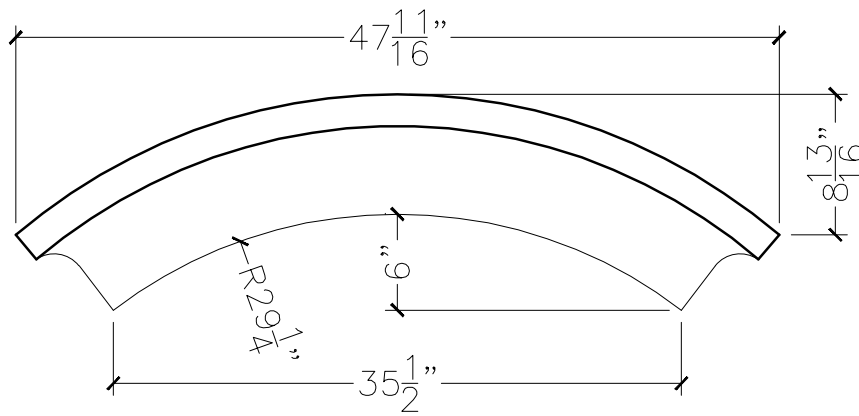

FRONT VIEW

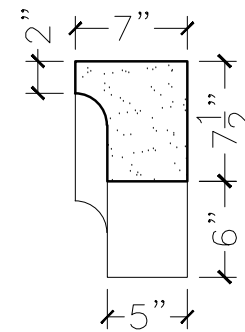

SECTION VIEW